



SHORT GUIDE  
Electrode inverter  
**BOOSTER.PRO 230**

**REHM SCHWEISSTECHNIK**



## Short guide

**BOOSTER.PRO 230**

Order No.: 1513230

**Manufacturer**  
**REHM GmbH u. Co. KG Schweißtechnik**  
**Ottostraße 2**  
**D-73066 Uhingen**

Telephone: +49 (0)7161/3007-0  
Telefax: +49 (0)7161/3007-20  
E-Mail: [rehm@rehm-online.de](mailto:rehm@rehm-online.de)  
Internet: <http://www.rehm-online.de>

Doc. No.: 7302157  
Date of issue: 17/08/2020

© REHM GmbH u Co. KG, Uhingen, Germany 2020

The content of this description is the property of Rehm GmbH u. Co. KG  
The copying and distribution of this document, its use and communication of its contents are strictly prohibited unless expressly authorized.

Offenders are liable to damages. All rights reserved in the event of patent, utility model or design patent.

The manufacture based on these documents is not allowed.

Subject to change.

---

## Contents

|          |  |           |
|----------|--|-----------|
| <b>1</b> | <b>General safety instructions.....</b>  | <b>3</b>  |
| <b>2</b> | <b>System description.....</b>           | <b>5</b>  |
| <b>3</b> | <b>Operation description .....</b>       | <b>6</b>  |
| 3.1      | Overview of the operating panel.....     | 6         |
| 3.2      | Operation in the main menu (Menu 1)..... | 7         |
| 3.3      | Current curve (Menu 2) .....             | 8         |
| 3.4      | Settings (Menu 3).....                   | 10        |
| <b>4</b> | <b>Circuit diagram .....</b>             | <b>11</b> |
| <b>5</b> | <b>Maintenance work.....</b>             | <b>12</b> |
| 5.1      | Safety information .....                 | 12        |
| 5.2      | Maintenance table .....                  | 12        |

## 1 General safety instructions



The system was developed and designed by the generally accepted rules of technology.

- Safety and warning instructions serve as occupational safety and accident prevention. They must be observed.
- Beside the advice given in this short guide, the general safety and accident prevention regulations (in Germany, among others UVV BGV A3, TRBS 2131 and BGR 500 Chapter 2.26 (previously VGB 15): "Welding, cutting and allied processes" and particularly the conditions for arc welding and cutting contained therein or the corresponding national regulations) must be observed.
- Also observe the safety information signs on the factory floor of the operator.
- All safety instructions and warnings as well as the nameplate on / near the system must be kept legible.
- Safety equipment must never be dismantled or put out of operation as this will result in dangerous hazards and the intended use of the system is no longer guaranteed. The dismantling of safety devices for equipping, repairing and maintenance is described in detail. The safety devices must be refitted immediately on completion of such work.
- Changes to the system or the mounting or incorporation of additional equipment as well as the decommissioning of safety devices are not permitted. Doing so will invalidate any warranty and liability claims.
- When using external aids and agents (for example, solvents for cleaning) the user of the system is responsible for ensuring the safety of the unit.
- REHM welding systems are, except when this is expressly stated in writing by REHM, only for sale to commercial / industrial users and are only intended to be used by commercial / industrial users.

### Technical data:

- Output current with electrode 140 A at a duty cycle of 100% (40°C)
- Output current with WIG 160 A at a duty cycle of 100% (40°C)
- Open circuit voltage from 85V
- Anti-stick function - no burn-out of the electrode if it accidentally sticks
- Protection type IP23

BOOSTER.PRO welding systems are designed in accordance with EN 60974-1 Arc welding equipment - welding power sources for overvoltage category III and pollution degree 3 and in accordance with EN 60974-10 Arc welding equipment - electromagnetic compatibility (EMC) for Group 2 Class A and should be suitable for use in all areas, except residential areas that are connected directly to a public low-voltage supply system. It may possibly be difficult to ensure electromagnetic compatibility in these areas due to both conducted and radiated interference. For this purpose, the use of appropriate measures to meet the requirements (filters for mains connection, shields such as shielded cables, the shortest possible welding cables, earthing of the workpiece, potential equalization) and assessment of the environment (such as computers, controllers, radio and television broadcasters, adjacent people, for example required in the use of cardiac pacemakers) are required. The responsibility for any fault lies with the user. For more information and recommendations, see, inter alia, DIN EN60974-10: 2008-09, Annex A.

#### **Qualification of the operating personnel**

REHM welding systems should be operated only by persons who are trained and instructed in the use and maintenance of welding systems. Only qualified, assigned and trained personnel may work on and with the system.



#### **Personal protective equipment (PPE)**

Personal protective equipment (PPE) is required when working with a welding system:

- Welding protection filter, protection level 10-15
- Protective shield, screen or hood
- Protective gloves
- Leather apron

The employer is obligated to provide the required PPE to the operator

#### **Environmental conditions**

- Temperature range of ambient air:
  - In operation: -10°C to +40°C (10°F to 104°F)
  - During transport and storage: -20°C to +55°C (-4°F to 131°F)
- Relative humidity:
  - to 50% at 40°C (104 °F)
  - to 90% at 20°C (68 °F)
- Ambient air:  
Free of unusual amounts of dust, acids, corrosive gases or substances, etc., unless they are produced during welding.
- Altitude above sea level: Up to 2000m (6500 ft).



Operation and storage of the system outside the specified range is considered to be improper. The manufacturer is not liable for any resulting damage.

#### **Requirements on the mains supply**

The system may be connected and operated from a single phase 2-wire system with earthed neutral conductor.

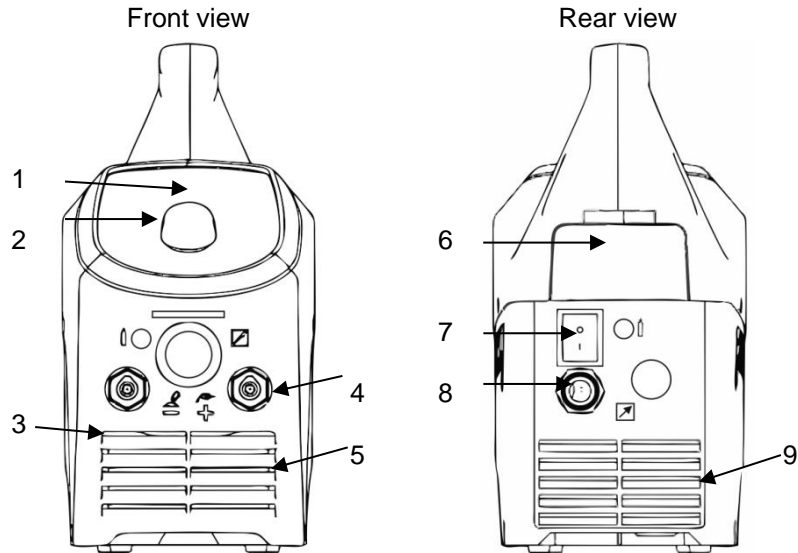
## 2 System description



| No. | Symbol  | Description   |
|-----|---|---|
| 1   |   | Control panel - See "Description of controls"   |
| 2   |   | Control panel push and rotate knob  |
| 3   | —  | Current socket "negative"<br>TIG:<br>TIG welding torch<br>Electrode:<br>Workpiece or electrode holder |
| 4   | +  | Current socket "positive"<br>TIG:<br>workpiece<br>Electrode:<br>Workpiece or electrode holder         |
| 5   |   | Cooling air inlet   |



| No. | Symbol | Description  |
|-----|--------|--|
| 6   |        | Drawer – storage for electrodes, gas nozzles, etc. |
| 7   |        | Main switch - On / Off                             |
| 8   |        | Power cable  |
| 9   |        | Cooling air outlet                                 |

### 3 Operation description

#### 3.1 Overview of the operating panel



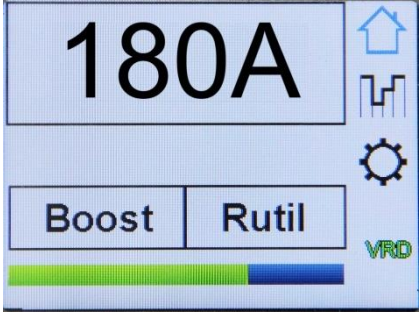
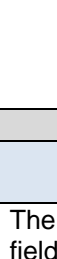
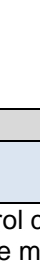

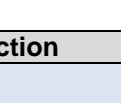
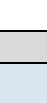

Fig 1: BOOSTER.PRO 230 control elements

| Controls  | Function  |
|---|---|
|  <p>Fig. 1 Main screen</p>             | <p>Main screen</p> <p>Operation via rotary encoder with push button.</p>  |
|  <p>Fig. 2 Push and rotary encoder</p> | <p>Rotary encoder with push-knob</p> <p>Moves the pointer (cursor) on the screen clockwise or counter clockwise. Positions reached are highlighted in colour and are activated by pressing the rotary encoder knob. Hold the push-knob down for two seconds to reach the main screen.</p> |

### 3.2 Operation in the main menu (Menu 1)



Fig. 2: Main menu

|                  | Symbols   | Description / function  |           |       |             |                  |    |                |                 |    |                |                  |     |  |                 |     |  |             |     |  |
|------------------|---|---|-----------|-------|-------------|------------------|----|----------------|-----------------|----|----------------|------------------|-----|--|-----------------|-----|--|-------------|-----|--|
| <b>Menu 1</b>    |    |   |           |       |             |                  |    |                |                 |    |                |                  |     |  |                 |     |  |             |     |  |
|                  |    | The control cursor is positioned in the "Current setting" field in the main menu as standard.<br>By pressing the rotary encoder the field will turn blue and the welding current can be changed. This can also be done in welding mode.<br>Pressing the rotary encoder once again confirms the value, the field will turn white and the set value is active.  |           |       |             |                  |    |                |                 |    |                |                  |     |  |                 |     |  |             |     |  |
|                  |    | The bar display shows in green the current range of the Booster.Pro. Blue is the range that still has to be set.  |           |       |             |                  |    |                |                 |    |                |                  |     |  |                 |     |  |             |     |  |
|                  |    | <b>Display of the welding function:</b><br><table border="1" data-bbox="837 896 981 1377"> <thead> <tr> <th>Procedure</th> <th>Boost</th> <th>Explanation</th> </tr> </thead> <tbody> <tr> <td>Rutile electrode</td> <td>No</td> <td>with fuse hold</td> </tr> <tr> <td>Basic electrode</td> <td>No</td> <td>with fuse hold</td> </tr> <tr> <td>Rutile electrode</td> <td>Yes</td> <td></td> </tr> <tr> <td>Basic electrode</td> <td>Yes</td> <td></td> </tr> <tr> <td>WIG LiftArc</td> <td>---</td> <td></td> </tr> </tbody> </table> <p>The boost function must be switched ON or OFF in the "Settings" menu  under "Fuse Hold".</p> | Procedure | Boost | Explanation | Rutile electrode | No | with fuse hold | Basic electrode | No | with fuse hold | Rutile electrode | Yes |  | Basic electrode | Yes |  | WIG LiftArc | --- |  |
| Procedure        | Boost   | Explanation   |           |       |             |                  |    |                |                 |    |                |                  |     |  |                 |     |  |             |     |  |
| Rutile electrode | No  | with fuse hold  |           |       |             |                  |    |                |                 |    |                |                  |     |  |                 |     |  |             |     |  |
| Basic electrode  | No  | with fuse hold  |           |       |             |                  |    |                |                 |    |                |                  |     |  |                 |     |  |             |     |  |
| Rutile electrode | Yes   |   |           |       |             |                  |    |                |                 |    |                |                  |     |  |                 |     |  |             |     |  |
| Basic electrode  | Yes   |   |           |       |             |                  |    |                |                 |    |                |                  |     |  |                 |     |  |             |     |  |
| WIG LiftArc      | ---   |   |           |       |             |                  |    |                |                 |    |                |                  |     |  |                 |     |  |             |     |  |
|                  |  | <b>Menu 1</b> Main screen<br><b>Menu 2</b> Current curve<br><b>Menu 3</b> Settings<br>It is possible to switch between the menus by turning and pressing.   |           |       |             |                  |    |                |                 |    |                |                  |     |  |                 |     |  |             |     |  |
|                  |  | VRD (Voltage Reduction Device) active.<br>The output voltage is limited to the very high-impedance and consequently safe sensor voltage of 24V.   |           |       |             |                  |    |                |                 |    |                |                  |     |  |                 |     |  |             |     |  |
|                  |  | If there are active pulses, the average value is used to set the current in the main menu.  |           |       |             |                  |    |                |                 |    |                |                  |     |  |                 |     |  |             |     |  |
|                  |  | An error has occurred, restart the device.<br>Contact the REHM customer service if the error persists.  |           |       |             |                  |    |                |                 |    |                |                  |     |  |                 |     |  |             |     |  |



### 3.3 Current curve (Menu 2)

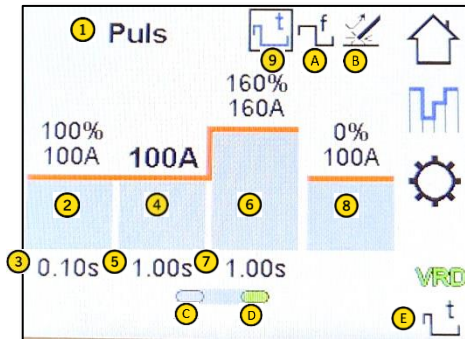



Fig. 3: Current curve







|               | Symbols | Description / function   |
|---------------|---------|--|
| <b>Menu 2</b> |         | <b>Current curve</b>   |
|               |         | Text display of the selected setting value (parameter) <ul style="list-style-type: none"> <li>• Hotstart</li> <li>• Hot-start-time</li> <li>• Current I1 setpoint</li> <li>• Current I2 setpoint</li> <li>• Frequency for hyperpulses (frequency pulses)</li> <li>• Arc force</li> <li>• Pulse</li> <li>• Hyperpuls</li> </ul>   |
|               |         | <b>Hot-start-current</b><br>Current increase for the Hot-start-time to ignite the arc safely.  |
|               |         | <b>Hot-start-time</b><br>Time when the hot start current is active   |
|               |         | <b>Pulse current (I1)</b><br>is the current displayed on the main screen (Menu1) which can also be adjusted from there.<br>When time pulses occur, current I1 is only present for time t1 and then changes to current I2 for time t2.<br>The current mean value results from $I1 \times t1 + I2 \times t2 / (t1+t2)$<br>e.g.: $120A \times 0.3s + 80A \times 0.3s / (0.3s+0.3s) = 100A$<br>At <b>hyperpulses</b> (frequency pulses) the currents I1 and I2 change with the set frequency (f)<br>The <b>percentage ratio</b> to I1 displayed at I2 remains unchanged when I1 is changed (I2 also changes) provided that this is possible from the setting values. |
|               |         | <b>Pulse-current time (t1)</b><br>Is displayed when time pulses are active.  |

|  | Symbols | Description / function  |
|--|---------|---|
|  | 6       | <b>Pulse-current (I2)</b><br>Only visible when time or hyperpulses (frequency pulses) are set.  |
|  | 7       | <b>Pulse-current time (t2) or frequency (f)</b><br>The time t2 or the alternating frequency f is set depending on whether time or hyperpulses (frequency pulses) are set.   |
|  | 8       | <b>Arc Force</b><br>Power to keep the arc stable. The value is always equal or higher than the current I1   |
|  | 9       | <b>Pulse On/Off</b><br>If the symbol is displayed in blue, the time pulse is activated, in black it is deactivated.<br>If the pulse is inactive, the I2 display goes out.   |
|  | A       | <b>HYPER.PULSE On/Off</b><br>If the symbol is displayed in blue, hyper pulsing is activated, in black it is deactivated.<br>If the pulse is inactive, the I2 display goes out.  |
|  | B       | <b>Anti Stick</b><br>This function prevents the electrode from sticking and is always active.   |
|  | C       | Pulse display inactive  |
|  | D       | Display time/hyper pulses active  |
|  | E       | The symbol  indicates that time pulses are active<br>The symbol  indicates that hyperpulses (frequency pulses) are active |

### 3.4 Settings (Menu 3)

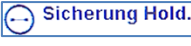

Fig. 4: Settings menu

|               | Symbols   | Description / function   |         |                             |                       |    |     |     |     |     |     |
|---------------|---|--|---------|-----------------------------|-----------------------|----|-----|-----|-----|-----|-----|
| <b>Menu 3</b> |    | <b>Settings</b>  |         |                             |                       |    |     |     |     |     |     |
|               |   | Process menu: <ul style="list-style-type: none"> <li>• Rutile electrode</li> <li>• Basic electrode</li> <li>• WIG LiftArc</li> </ul>   |         |                             |                       |    |     |     |     |     |     |
|               |  | Software version of the machine - Power control  |         |                             |                       |    |     |     |     |     |     |
|               |  | Software version of the operation  |         |                             |                       |    |     |     |     |     |     |
|               |  | The fuse limitation can be activated or deactivated here.<br>(Limits the maximum adjustable current) <table border="1" data-bbox="603 1339 1141 1496"> <thead> <tr> <th>Setting</th> <th>Electrode max. current in A</th> <th>TIG max. current in A</th> </tr> </thead> <tbody> <tr> <td>On</td> <td>160</td> <td>230</td> </tr> <tr> <td>Off</td> <td>180</td> <td>230</td> </tr> </tbody> </table> | Setting | Electrode max. current in A | TIG max. current in A | On | 160 | 230 | Off | 180 | 230 |
| Setting       | Electrode max. current in A   | TIG max. current in A  |         |                             |                       |    |     |     |     |     |     |
| On            | 160   | 230  |         |                             |                       |    |     |     |     |     |     |
| Off           | 180   | 230  |         |                             |                       |    |     |     |     |     |     |
|               |  | Menu language selection  |         |                             |                       |    |     |     |     |     |     |
|               |  | All of the unit settings can be reset to factory settings here.  |         |                             |                       |    |     |     |     |     |     |

# 4 Circuit diagram

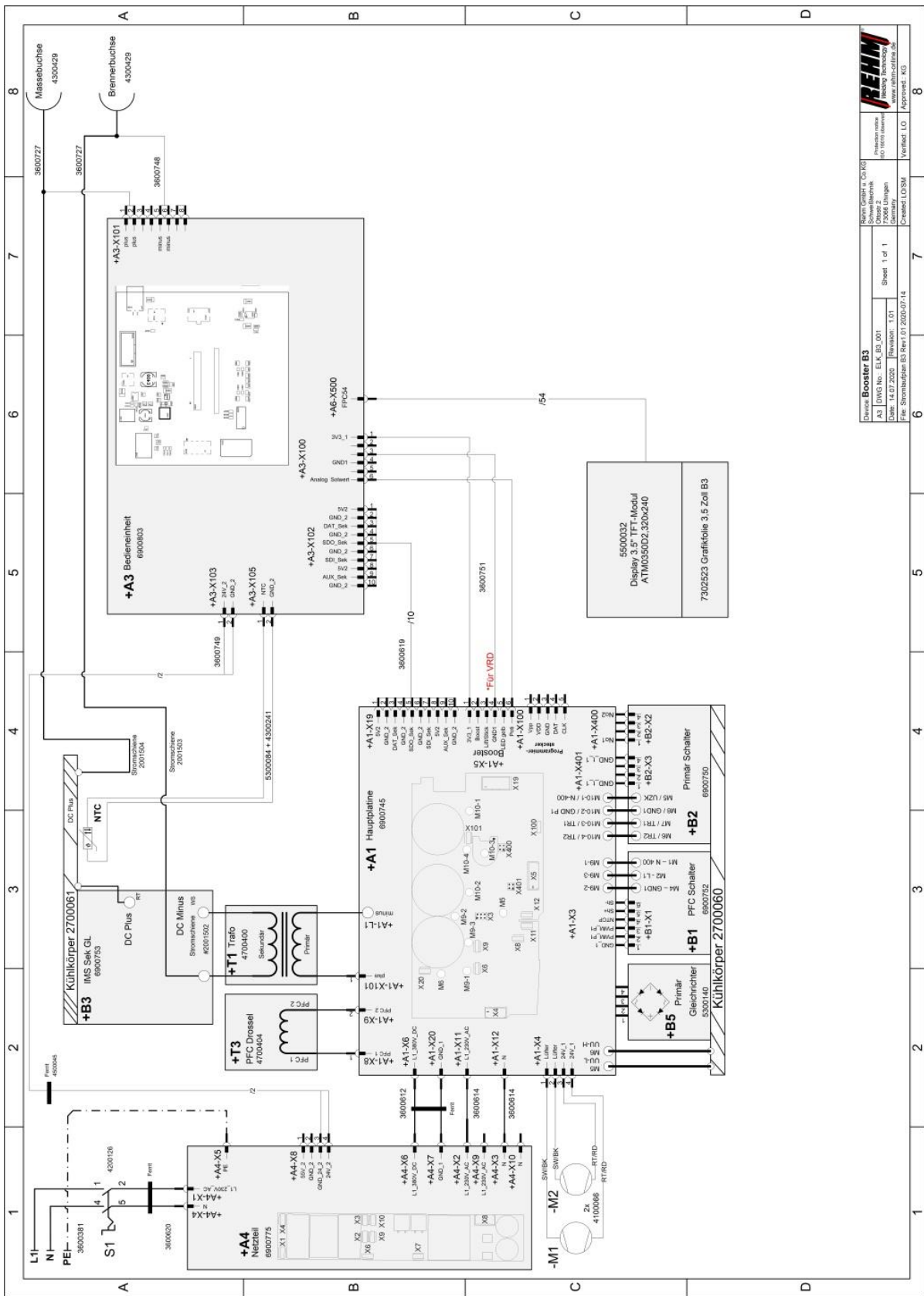

|  |  |                                |  |
|--|--|--------------------------------|--|
| Device: <b>Booster B3</b>                      |  | Version: <b>03/21 L. CS/20</b> |  |
| AZ: <b>0000 No. - EUC_B3_001</b>               |  | Produktion: <b>01/2019</b>     |  |
| Date: <b>14.07.2020</b>                        |  | Revision: <b>1.01</b>          |  |
| File: <b>Strombaufbau_B3 Rev 01 2020-07-14</b> |  | Sheet: <b>1 of 1</b>           |  |
| Created: <b>LOSM</b>                           |  | Verified: <b>LO</b>            |  |
| Approved: <b>KG</b>                            |  | www.rehm-online.de             |  |

## 5 Maintenance work

### 5.1 Safety information

#### Warning!

Maintenance and repair work may only be performed by persons who have been trained by REHM. Please contact your REHM dealer.

When replacing parts only use REHM original spare parts.

If maintenance or repair work is performed on this unit by persons who have not been trained and authorised to carry out the work by REHM, then claims against REHM become void.

Before beginning cleaning work the unit must be switched off and disconnected from the mains supply.

Before maintenance work the welding system must be switched off and disconnected from the mains supply and secured against unintended reconnection.

Supply lines must be shut off and vented free of pressure.

The welding system and its components must be maintained in accordance with the requirements of the operating and maintenance instructions.

Insufficient or improper maintenance or repair may result in operating faults. Periodic maintenance of the system is therefore essential. No constructive change or additions may be made to the system.

### 5.2 Maintenance table

The maintenance intervals are recommended by REHM for standard requirements (for example, single shift operation, use in a clean and dry environment). The precise maintenance intervals are specified by your safety officer.

| Activity  | Interval  |
|---|---|
| Cleaning the inside of the unit   | According to the conditions of use                      |
| Functional test of the safety equipment by operating personnel  | Daily   |
| Visual system check, particularly the torch hoses / welding current cable   | Daily   |
| Check the function of the residual current circuit breaker  | Daily<br>(in flying constructions)<br>otherwise monthly |
| Have the connecting lines and torch hoses checked by qualified personnel; log the checks in the logbook provided.<br><b>Perform checks more regularly depending on the country-specific laws.</b> | Every six months  |
| Have the complete welding system checked by qualified personnel; log the checks in the logbook provided.<br><b>Perform checks more regularly depending on the country-specific laws.</b>          | Annually  |



### **EG declaration of conformity**

For the following named products

#### **BOOSTER.PRO 230**

it is hereby confirmed that they comply with the essential protection requirements which are laid down in the Directive 2014/30/EU (EMC Directive) of the council on the approximation of the laws of the Member States relating to electromagnetic compatibility and in the Directive 2014/35/EU relating to electrical equipment designed for use within certain voltage limits.

The above products comply with the requirements of this directive and comply with the safety requirements for arc welding units in accordance with the following product standards:

EN 60974-1: 2018-12

Arc welding equipment - Part 1: Welding current source

EN 60974-3: 2015-12

Arc welding equipment - Part 3: Arc striking and stabilizing devices

EN 60974-10: 2016-10

Arc welding equipment - Part 10: Electromagnetic compatibility (EMC) requirements

according to the EC. Directive 2006/42/EC article 1, paragraph 2 the above mentioned products fall exclusively within the scope of the directive 2014/35/EC relating to electrical equipment designed for use within certain voltage limits.

This declaration is given for the manufacturer:

**REHM GmbH u. Co. KG Schweißtechnik**  
**Ottostr. 2**  
**73066 Uhingen**

Uhingen, 17.08.2020

submitted by

---

R. Stumpp  
*Managing Director*



**REHM** GmbH u. Co. KG Schweißtechnik  
Ottostraße 2 | 73066 Uhingen | Germany

Tel.: +49 (0) 71 61 3007-0  
Fax: +49 (0) 71 61 3007-20

E-Mail: [rehm@rehm-online.de](mailto:rehm@rehm-online.de)  
Internet: [www.rehm-online.de](http://www.rehm-online.de)